

CEO-24-HC22 Series

Owner's Manual - Installation
and Operating Instructions

Rev. 3.0 – 02.07



Cottage Call
7 First Ave
Orangeville, ON L9W 1H7



Please read this manual carefully before installation and use.

Index

Options	1
Accessories	2
Wiring Connections	3
Hardware Jumpers Configuration	4
Operating Manual.....	5
Programming	6
Override set temperature	7
Economy Mode (Set Back Mode)	8
Alarm Conditions (red LED light).....	9
General purpose output - "OUT, OUT"	10
Thermostat Reset	11
Technician Settings.....	12
Connection of External sensor	13
Telephone Settings.....	14
Menu of Commands from Telephone to Thermostat	15
Troubleshooting for Technician	16

1. Options

- Programmable or non-programmable: to select, press one button and the program will remain in memory (No need to reset it again).
- External Temperature Sensor - (return air or wall mounted).
- High and Low Temperature Alarm (Dry contact) - alarm is indicated by RED led.
- Scale in Fahrenheit or Celsius- must be specified at time of order.
- Individual cooling and heating set points.
- Fault indication 1 (24Vac)
- Fault indication 2 (normally open, dry contact)

2. Accessories

- Back Plate - 6"L x 4"W x 0.37"H - Part No. WP2.
- Wide Back Plate - 6"L x 6"W x 0.37"H – Part No. WP3.
- Temperature Sensor with 30 inches lead - Part No. TS01.
- Temperature Sensor in decorative box - Part No. RS01.
- Two temperature sensors in a decorative box (for averaging) - Part No. RS02
- Duct temperature sensor - Part No. DT02.



For details on where to purchase accessories, please contact Meitav-tec for your nearest location or visit web site as www.meitavtec.com

3. Wiring Connections

3.1 Phone line - wiring diagram.

The **CEO-24** thermostat has a telephone line connection, exactly like an answering machine or a modem, and is connected in the same way.

The thermostat has 2 telephone line outputs (TEL, TEL), where polarity is irrelevant.

Connection to a regular telephone jack

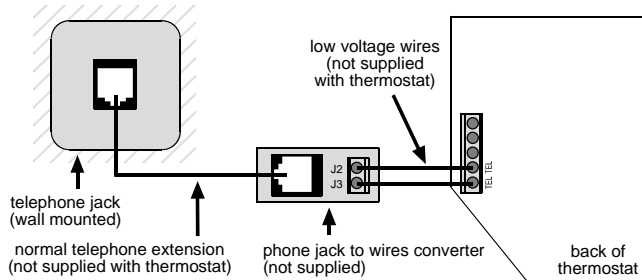

Connection to a DSL micro-filter

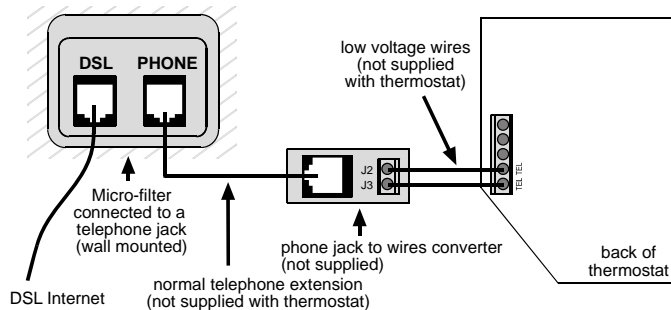

3.2 Connections for all applications

Terminal	Input/Output
C	24Vac Common from transformer
R	24Vac RED
IN,0	Alarm input – normally open (option) -Alarm 2
AX	Fault input from system (24Vac)-Alarm 1
AL,AL	Alarm output (N.O. dry contact) – activated when the temperature reaches preset alarm limits or/and when fault input from system is active.
MIL	Low voltage input to be utilized by the W1 output (*jumper position dependent)
W1	Heating 1 st Stage
G1	Fan
Y1	Cooling 1 st Stage
W2	Heating 2 nd Stage
Y2	Cooling 2 nd Stage
OUT,OUT	Normally open, dry contact, general purpose output, activated manually or by phone command (option).
W3	Not in use
T0	Not in use
0,T1	External sensor
TEL, TEL	Telephone line

*See jumper configuration



IMPORTANT! Before making any changes to the jumpers disconnect electricity to the main board.

4. Hardware jumpers Configuration

4.1 The Jumpers are located as shown in the picture:

Base plate

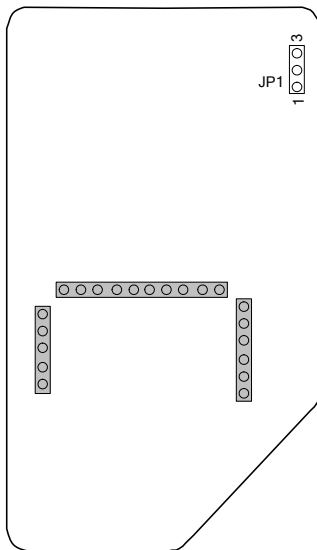

Front plate

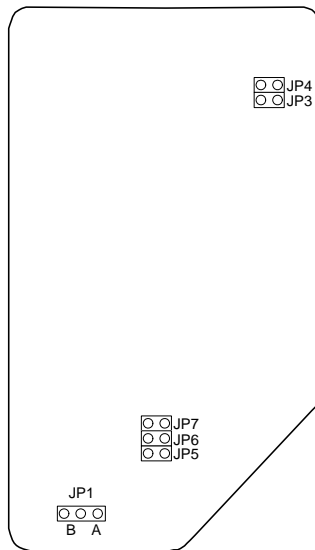

Front plate – jumper configuration:

Jumper No.	Function	Position	Default
JP1	Internal Sensor Control	“B” Position	X
	External sensor control	“A” Position	
JP3	4 minutes delay for compressor	Open	X
	No delay	Short	
JP4	Clock mode – 24 hours	Open	
	Clock mode – 12 hours (AM/PM)	Short	X
JP5	NOT IN USE		
JP6	“OUT,OUT” outputs not active	Open	
	“OUT,OUT” outputs active	Short	X
JP7	Heat mode - Electric	Open	X
	Heat mode - Oil/Gas	Short	

Base plate – jumper configuration:

Jumper No.	Function	Position	Default
JP1	24Vac to “W1” output.	“3” Position	X
	Voltage to “W1” output utilizes the voltage applied to the “MIL” input. (Can be used to supply any low voltage other than 24Vac)	“1” Position	

5. Operating Manual

5.1 Turn the thermostat On or Off

- Press the **On/Off** button to activate the thermostat – The Green LED will turn on.
- Press and hold the **On/Off** button (5 seconds) to turn the thermostat off – The Green LED will turn off.

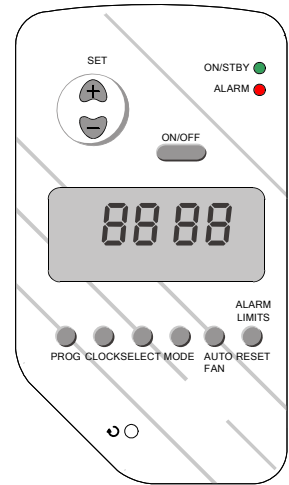

5.2 Real time clock and day

- Press the **Clock** button – the hours will flash.
- Adjust the hours using the “+” and “-” buttons (set buttons).
- Press the **Clock** button again – the minutes will flash.
- Adjust the minutes using the “+” and “-” buttons.
- Press the **Clock** button again – the day of the week will flash.
- Set the day of the week using the “+” and “-” buttons.
- Press the **Clock** button again to return to normal display mode.

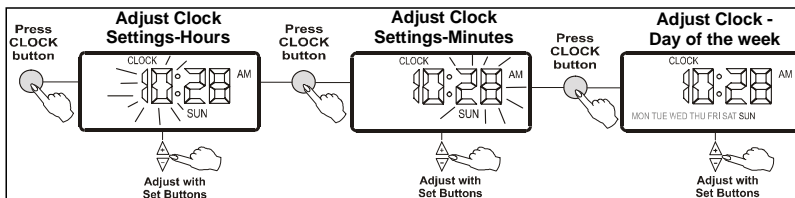

5.3 Selecting modes

Press the **Mode** button to switch between the four modes:

- Cool – “COOL” appears on display.
- Heat – “HEAT” appears on display.
- Cool/heat (auto-change over) – both “COOL” and “HEAT” **appear** on display.
- Fan only – both “COOL” and “HEAT” **disappear** from display.

5.4 Set temperature

Set temperature in Cool and Heat modes.

- Press the “+” or “-” buttons - set temperature will flash.
- Adjust the set temperature using the “+” or “-” buttons.
- Wait until display returns to normal mode.

Set temperature in auto change-over mode.

- Press the “+” or “-” buttons – “COOL” and set temperature for cooling will flash.
- Adjust the set temperature for cooling using the “+” or “-” buttons.
- Wait 3 seconds – “HEAT” and set temperature for heating will flash.
- Adjust the set temperature for heating using the “+” or “-” buttons.
- Wait until display returns to normal mode.



In auto change-over mode, the thermostat has 2 different set points – one for cool and one for heat. The set temperature for heat must be at least 1 degree LESS than the set temperature for cool. The thermostat will automatically adjust the set temperature for heat to be less than the set temperature for cool.



In auto change-over mode – a **solid “|”** sign will appear next to the mode to indicate that the current displayed set-point temperature is of that mode.

A **flashing “|”** sign next to the mode will indicate the current active mode.

Display of set-point temperature for heat

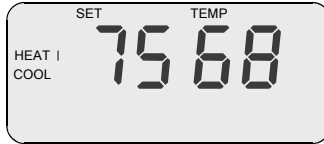

Heating mode active



Display of set-point temperature for cool



Cooling mode active

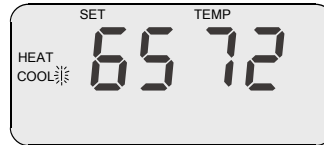

5.5 Selecting fan/auto fan

Press the **Auto Fan** button to switch between:

- FAN ON – The fan will work continuously.
- Auto Fan – The fan will work according to cooling/heating demand (“AUTO FAN” appears on display)



In Oil/Gas systems, in heat mode, switching to Auto Fan mode, (the Fan is only turned on via furnace temperature sensor).

6. Programming

The thermostat is 5-1-1 weekly programmable, meaning;
Weekdays - Monday through Friday / Saturday / Sunday have individual programs.
There are four different program events per day.

Program Display

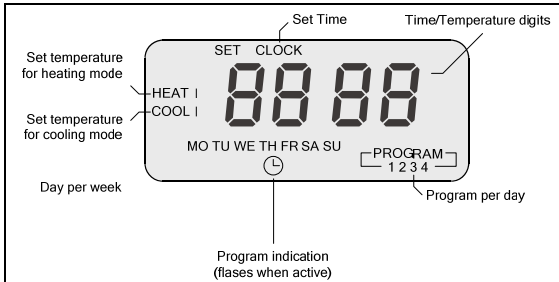

6.1. Setting the Program

Pressing the **Prog** button does all Programming selections

- Press the **Prog** Button - the hour and minute will flash.

This shows that you are entering the **Prog** mode.

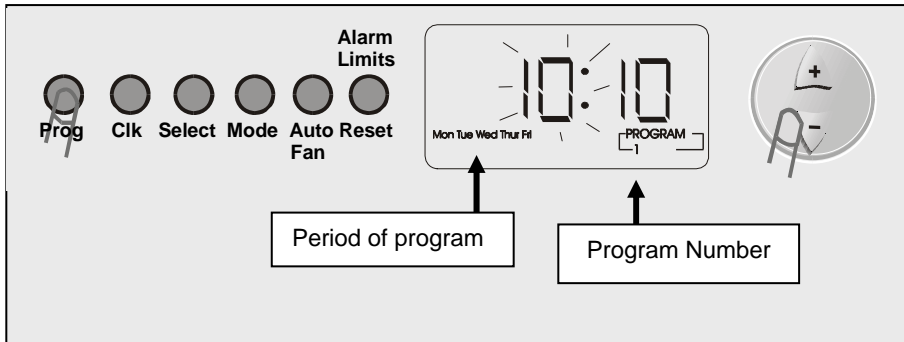

- Press the **Prog** button again - the minutes on display will flash.
- Adjust the minute using the '+' and '-' buttons.

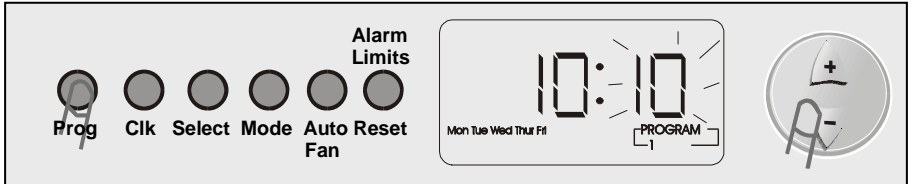

- Press the **Prog** button again - heat and temperature on display will flash.
- Adjust the set temperature for heating using the '+' and '-' buttons.

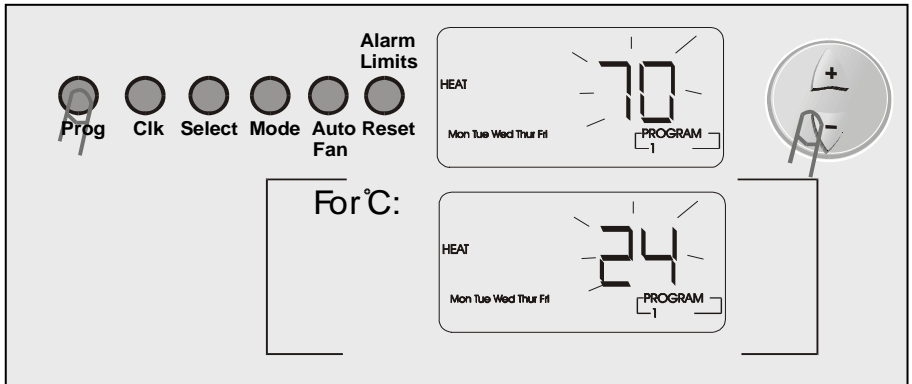

- Press the **Prog** button again - cool and temperature will flash.
- Adjust the set temperature for cooling using the '+' and '-' buttons.



The controller keeps a safe differential of at least 1 degree between Heat set and Cool set (Heat is always less than Cool).

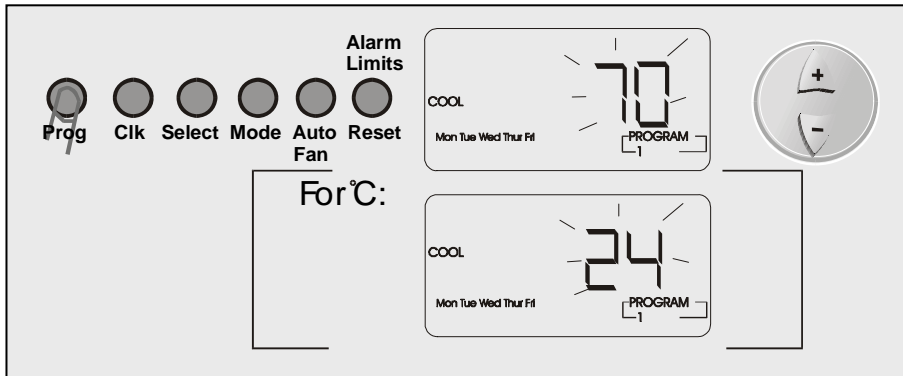

- To set the time and temperature for the other programs repeat the steps above.
- Press the **Prog** button again to return to normal display.

6.2. Weekly Program Mode and Manual Mode.

You can change between weekly program and Manual program, by pressing and holding (3 seconds) the **Prog** button in normal display.

When the weekly program is activated, the clock symbol and the word “Program”, (in brackets) will be displayed.

The clock symbol and Program, in brackets, will not be displayed in Manual Mode.

6.3. Review the Program

You can review the program or change part by entering into the program mode and step quickly through by pressing **Clock** button.

7. Override Set Temperature

- At anytime you can change the temperature by pressing the ‘+’ and ‘-’ buttons.
- The new temperature will be retained until the next program start.
- If the thermostat was in program mode, then the number of the program will disappear until the next program.

8. Economy Mode

Economy mode overrides the set point temperature and uses set economy temperatures for heat and cool when you leave home or office for any period of time - vacation, unexpected event - and the system will work in economy mode.

(To set temperature for economy mode See # 11.6)

8.1 Set the thermostat to work in Economy Mode.

- Switch on the thermostat
- Press and hold the **Auto Fan** button (10 sec.) until the buzzer "beeps" – 'EC' (Economy) will appear on display.
- When returning home (office) - Press and hold (10 sec.) the **Auto Fan** button until the buzzer "beeps" and the set temperature returns to normal.



In Economy Mode, none of the buttons function except for the Auto Fan button.



The green LED will light to show that the thermostat is working but the system may be turned off because there is no demand for Heating or Cooling.



The Economy Mode could be activated even if the thermostat is OFF by pressing the Auto Fan button for 10 seconds. When coming out of Economy Mode (press and hold the Auto Fan button for 10 seconds again) the thermostat will return to its last state.

9. Alarm Conditions (Red LED)

Alarm type	Red LED indication	Thermostat operation	Tel. voice response	Reset button operation
temperatures goes higher or lower than the alarm limits set by the technician	Flashes slowly	The "AL,AL" outputs will be activated	"You have an alarm condition. Temperature in the room is..."	None
Fault input from system (24Vac)	Solid light	The "AL,AL" outputs will be activated	"You have an alarm condition 1"	Press and hold the Reset button to stop the "AL,AL" output
Alarm input through "IN,0" (N.O. dry contact) -optional	Flashes rapidly		"You have an alarm condition 2"	



The alarm works whether the thermostat is On or Off.

10. General Purpose Output – "OUT, OUT"

Normally open, dry contact, general purpose output that can be activated manually or by phone command.

The output can be connected to a boiler, or other consumer, and can be activated remotely using phone command when you are NOT in the house.

The output can be controlled using 3 commands:

- A. Turn the output ON.
- B. Turn the output OFF.
- C. Activate the output for a set number of hours.

10.1 Manual Operation of the output.

- Press the **Select** button several times until "t ##" will appear on display (where ## stands for number of hours – two digits).
- Using the "+" or "-" buttons, adjust the number of hours for the output to be ON (starting from present time) – range 01...23 hours.
Set the number to "00" to turn the output OFF.
Set the number to "24" to turn the output ON without time limitation.
- Press the **Select** button again for the command to take affect and to return to normal display.

* **The output can be activated through the phone – please refer to section #15.**

11. Thermostat Reset

The hidden button on the bottom left side of the thermostat can be used to:

1. Reset the thermostat to its default settings.

- Press and hold the “+” button.
- Simultaneously, press and release the hidden button.
- Release the “+” button.

2. Return the thermostat to its previous state.

- Press and release the hidden button.



12. Technician settings

These settings allow the user to change the following:

- High temperature alarm.
- Low temperature alarm.
- Set-point for cool in economy mode.
- Set-point for heat in economy mode.

12.1 Enter code for technician

- Press the **Alarm Limit** button - 'C50' will appear on display.
- The code is 55.
- Enter the code using the '+' and '-' buttons.

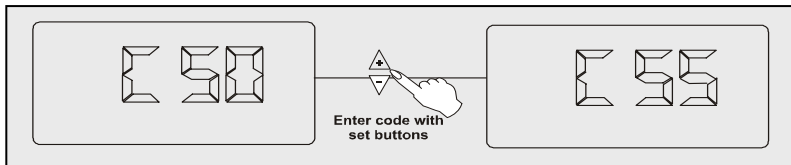

12.4 Set High temperature alarm - HA:

- Press the **Alarm Limit** button again - the LCD will show "**HA ##**" (Where "##" stands for high alarm limit – two digits).
- Adjust the temperature using the '+' and '-' buttons. (From 34°F-99°F or 2°C-38°C - default=98°F or 36°C) so when the ambient temperature reaches the High Temperature limit, the alarm activates.
- Press the **Alarm Limit** button again.

12.5 Set Low temperature alarm - LA:

- Press the **Alarm Limit** button again - the LCD will show "**LA ##**" (Where "##" stands for low alarm limit – two digits).
- Adjust the temperature using the "+" and "-" buttons. (From 33°F-98°F or 1°C-37°C - default=35°F or 5°C).
The unit will not allow you to set the Low Temperature limit higher than the High Temperature limit.
- Press the **Alarm Limit** button again.

12.6 Set Economy mode - cooling:

- Press again to set Economy Mode for cooling - the LCD will show "**EC ##**" and "**COOL**" (Where "##" stands for set-point temperature for cool in economy mode – two digits).
(From 41°F-90°F or 24°C-35°C - default=77°F or 25°C).

12.7 Set Economy mode - Heating:

- Press again and set Economy Mode for heating - the LCD will show "**EC ##**" and "**HEAT**" (Where "##" stands for set-point temperature for heat in economy mode – two digits).
(From 40°F-89°F or 5°C-32°C - default=60°F or 15°C).

13. Connection of External Sensor



Important! The external sensor must be Meitav-tec type.

N.TC. Sensor: Temperature ~ Resistance Characteristics

Temp °C	7.2	10.0	12.8	15.6	18.3	21.1	23.9	26.7	29.4	32.2
Temp °F	45	50	55	60	65	70	75	80	85	90
Res. k	115.8	100.9	88.1	77.1	67.7	59.6	52.5	46.4	41.2	36.6

- Disconnect power to the thermostat 24Vac.
- Move Jumper 1 (on front plate) to position A. see # 4.1
- Connect the temperature sensor to T1,0 terminals.
- Reconnect power 24Vac.

14. Telephone settings

The CEO-24 will call the user when one of the following occurs:

- The ambient temperature goes above the High Temperature limit
- The ambient temperature goes below the Low Temperature limit
- Fault input from system (24Vac)
- Alarm input* through "IN,0" (optional)

*The connection to the dry contact "IN,0" can be from any system determined by the user, for example; home alarm system, occupancy sensor, equipment fault.

Choosing a Password

- Press the **Select** button - A four (4) digit password will appear: 1 2 3 4. (Default from factory)
- Select a code number, which is easy to remember (four digits).
- Set the first number using the '+' and '-' buttons.
- Press the **Select** button again to change the second number.
- Set the second number using the '+' and '-' buttons.
- Change the third and fourth number in the same way.



The user **MUST** enter this password when responding to the CEO-24 call. Otherwise the thermostat will hang up.

Setting the Thermostat Response to Incoming Calls

- Press the **Select** button again – "**TAD0**" appears on LCD.
- Choose between "TAD 0" and "TAD 1" using the '+' and '-' buttons.
 - 'TAD 0' = The thermostat will answer an incoming call immediately.
 - 'TAD 1' = The thermostat will answer an incoming call after a preset number of rings. This feature allows the unit to be connected to the same phone line as another device, such as: answering machine, fax, etc.

Selecting "TAD1" does not affect the calling-out feature of the CEO-24. However, when making incoming call TO the thermostat, the following must be noted:

If "TAD1" is selected:

You must call the thermostat twice.

First, you must know the set number rings of the other device connected.

The number of rings of the thermostat must be more than the number rings of the other device.

On the first call, the user must hang up before the other device answers.

On the second call, the thermostat will know to answer if it is within 30 seconds of the first call.

E.g. Number rings for answering machine is 4.

Number rings for the CEO-24 is 5.

Follow these steps:

1. Set the ring setting to 6 rings (see below).
2. Call the CEO-24.
3. Let the telephone ring 3 times and hang up.
4. Wait for 4-5 seconds, and call again
5. The CEO-24 will answer after the second ring on the second call, before any other device.

To set the number of rings for the CEO-24:

- Press the **Select** button again – "**Fn 02**" will be displayed.

This is the set number of rings after which the CEO-24 should answer. For the example above, FN should be set to 6.

If no device other than the thermostat is connected to the phone line, then the number of set rings for the CEO-24 should be at least 6.

This will ensure that the user has time to answer the telephone before the call is answered by the thermostat.

Programming Telephone Numbers

The CEO-24 can be programmed with up to 3 different telephone numbers (up to 16 digits each). Each of these numbers will be called by the thermostat twice, in case there is no answer or the password is not entered. This process will repeat itself every 2 minutes, until the call is answered.

Follow the steps below to program the telephone numbers:

Press the **Select** button again – 'n1' will be displayed.

- This is the first telephone number that the thermostat will call.
- Press the '+' button – the number '5' will be displayed.
- Using the '+' or '-' buttons select the first digit of the telephone number.
- Press the **Select** button again to switch to the second digit.
- Using the '+' or '-' buttons select the second digit of the telephone number.
- Repeat this sequence until the full number is entered.
- Press the **Select** button twice to switch to the second telephone number 'n2'.
- Repeat the steps above to the second and third telephone numbers.

Important: When changing one of the programmed numbers simply override the old number digits using the "+" and "-" buttons. If the new number has fewer digits than the old one enter the new shorter number and then press and hold **Select** button to erase the remaining digits of the old number.

15. Menu of commands from a telephone to the thermostat

- Enter your password: 1•2•3•4•# (factory default - or any other code you have chosen 4 numbers only)

You will hear the status of the system:

- a. Temperature in the room is...
- b. System is now... (ON or OFF)
- c. Mode is now... (Cool, heat, fan, auto change over)...
- d. Set cooling temperature is...
- e. Set heating temperature is...
- f. Please enter your desired command (see list of commands on the next page)

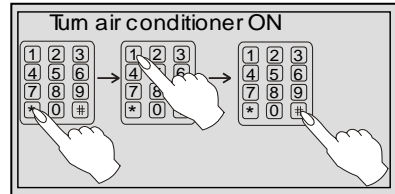

At the end of each session, press *9# to save the new commands.

Read full List of commands
(press *0#)

End of session
(press *9#)

Turn thermostat ON
(press *1#)

Turn thermostat OFF
(press *2#)

Temperature set-point for cooling
(press *3#)

Temperature set-point for heating
(press *4#)

Enter temperature and then enter #

Enter temperature and then enter #

Mode
(press *5#)

Program On/Off
(press *6#)

Economy On/Off
(press *7#)

Turn the "OUT; OUT" output (channel) ON or OFF
(press *8#)

Select between:
- Auto change-over (press 1#)
- Fan only (press 2#)
- Cooling (press 3#)
- Heating (press 4#)

Select between:
- Program ON (press 1#)
- Program OFF (press 2#)

Select between:
- Economy ON (press 1#)
- Economy OFF (press 2#)

Select between:
- The output is ON continually (press 24#)
- Turn output OFF (press 00#)
- Turn output ON for a set number of hours (press XX#)
XX=01 to 23 Hours

16. Troubleshooting for Technician

Problem	Solution
The display does not light	The unit is not getting 24Vac - Check the wiring connections, R (Phase), C(common).
Temperature in the room (display) dropped to 0°F	<p>The temperature sensor is sensing an OPEN CIRCUIT.</p> <p>Replace the jumper JMP1. If the temperature returns to normal - there is a problem with the external sensor.</p>
Temperature in the room (display) rises to 99°F	The temperature sensor is sensing a SHORT CIRCUIT.
The unit does not respond to buttons and "EC" appears in the display	<p>The unit is in Economy Mode.</p> <p>To return to normal mode, see #8.</p>
In heat mode, unit sends cool air	The Auto Fan is not ON.
TEL appears on the display	The thermostat is currently calling or receiving a call.
Reset the unit – See 10	